



ACF

VENTILATOREN



***Radialventilator
Baureihe: VA***

VA

VENTILATORE AD ALTO RENDIMENTO
HIGH EFFICIENCY FAN



GIRANTE A PALE CURVE ROVESCE
BACKWARD CURVED BLADES IMPELLER



ALTISSIMA PRESSIONE
VERY HIGH PRESSURE

Portata/Flow rate:
65 ÷ 1450 m³/h

Pressione/Pressure:
120 ÷ 2000 mm H₂O



ACF



Ihr Partner für Ventilatoren
Stahl | Edelstahl | Aluminium Kunststoff

VA

VENTILATORE AD ALTO RENDIMENTO HIGH EFFICIENCY FAN



Ventilatore ad alto rendimento: Mod. VA.

Campo di lavoro: portate piccole, prevalenze alte.

Tipo di pale: rovesce positive.

Applicazioni: per trasporto pneumatico, polveri, essiccazione, pressurizzazione. Adatto per impieghi nel campo industriale delle fonderie, pastifici, forni, chimico.

Temperatura del fluido: fino a 60° C in esecuzione standard; esecuzioni speciali per temperature superiori.

Caratteristiche costruttive: ventilatore di costruzione particolarmente robusta eseguito in lamiera verniciata, ventola in acciaio equilibrata staticamente e dinamicamente.

Caratteristiche di funzionamento: condizioni dell'aria in aspirazione $T = 15^{\circ} \text{C}$, $p = 1 \text{ atm}$.

High efficiency fan: Mod. VA.

Field of application: low capacities, high pressures.

Type of blades: forward, positive.

Applications: for pneumatic conveyance, dirty air, drying systems.

Particularly suitable for foundries, food and chemical industry.

Air temperature: up to 60° C standard, special features for higher temperatures.

Construction specifications: rigid construction in sheet metal.

Statically and dynamically balanced impellers.

Working principles: condition of the ducted air $T = 15^{\circ} \text{C}$, $p = 1 \text{ atm}$.



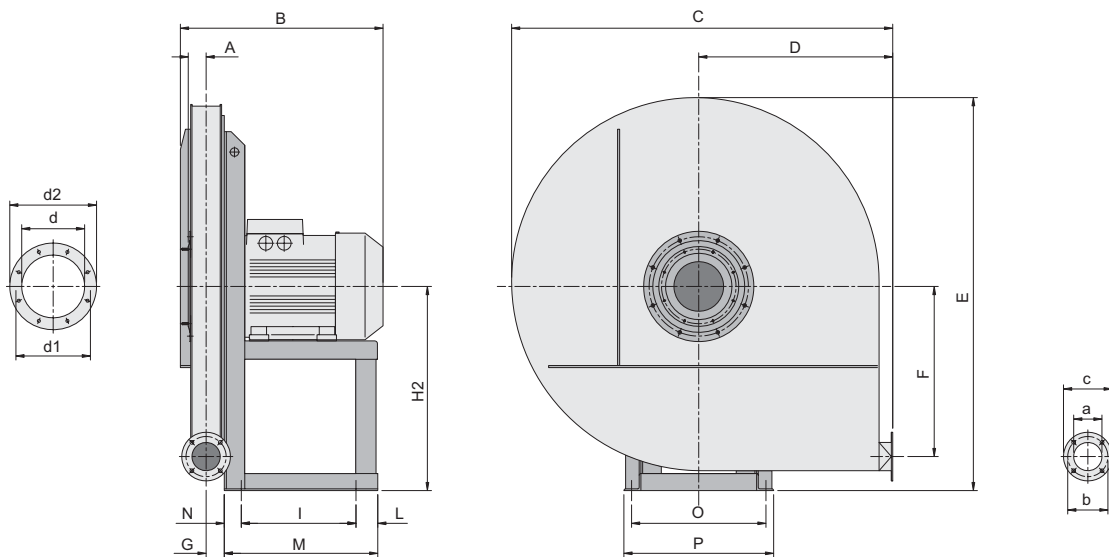

Orientamento RD 270
Position RD 270

Direzioni di rotazione (vista lato motore) - Rotation senses (seen from motor side)

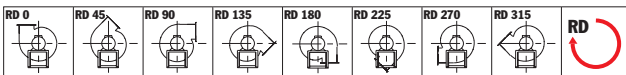

Rotazione oraria - Clockwise rotation sense

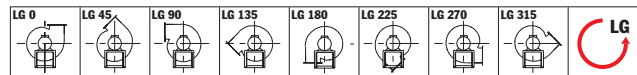

Rotazione anti-oraria - Anti-Clockwise rotation sense

DIMENSIONI D'INGOMBRO

OVERALL DIMENSIONS



VA 310÷900

Peso ventilatore in Kgf (completo di motore) - Weight of ventilator (complete with motor)

Nota: Quota B indicativa - Note: B quote indicative

TIPO - TYPE		PESO WEIGHT	PD ² GD ²	VENTILATORE FAN									
VENTILATORE FAN	MOTORE MOTOR			kgf	kgf m ²	A	B	C	D	E	F	G	H
VA 310/P	63 B2	22	0,15	34	280	515	270	520	220	30	280	280	280
VA 350/P	71 A2	24	0,23	34	305	515	270	520	220	30	280	280	280
VA 400/P	71 B2	36	0,37	34	305	675	350	673	300	31	355	355	355
VA 450/P	80 A2	39	0,53	34	340	675	350	673	300	31	355	355	355
VA 500/P	80 B2	42	0,73	34	340	675	350	673	300	31	355	355	355
VA 560/P	90 S2	59	1,1	34	370	780	405	800	355	32	425	425	425
VA 631/P	90 S2	63	1,8	34	370	780	405	800	355	32	425	425	425
VA 632/P	90 L2	66	2										
VA 711/P	100 LA2	94	2,7	40	440	880	455	900	400	38	475	475	475
VA 712/P	112 M2	100	3,4		485								
VA 801/P	112 M2	111	4	40	485	980	505	1010	450	38	530	530	530
VA 802/P	132 SA2	125	5,4		525								
VA 901/P	132 MB2	152	8,7	49	550	1120	570	1140	500	48	600	600	600
VA 902/P	160 MA2	210	10,8		630								

TIPO - TYPE	FLANGIA ASPIRANTE INLET FLANGE					FLANGIA PREMENTE OUTLET FLANGE					BASAMENTO BASE														
	VENTILATORE FAN	d	d ₁	d ₂	n°	∅	a	b	c	n°	∅	I	J	K	L	M	N	O	P	Q	R	S	T	U	∅
VA 310/P	145	182	215	8	8	54	84	104	4	8	86	-	-	14	145	45	184	206	-	-	-	-	-	-	10
VA 350/P	145	182	215	8	8	54	84	104	4	8	121	-	-	23	189	45	203	225	-	-	-	-	-	-	10
VA 400/P	145	182	215	8	8	54	84	104	4	8	121	-	-	23	189	45	203	225	-	-	-	-	-	-	10
VA 450/P	145	182	215	8	8	54	84	104	4	8	121	-	-	45	211	45	203	225	-	-	-	-	-	-	10
VA 500/P	145	182	215	8	8	54	84	104	4	8	121	-	-	45	211	45	203	225	-	-	-	-	-	-	10
VA 560/P	145	182	215	8	8	54	84	104	4	8	133	-	-	58	246	55	234	260	-	-	-	-	-	-	10
VA 631/P	145	182	215	8	8	54	84	104	4	8	133	-	-	58	246	55	234	260	-	-	-	-	-	-	10
VA 632/P																									
VA 711/P	165	200	235	8	8	66	102	126	4	8	197	-	-	59	276	30	289	324	-	-	-	-	-	-	12
VA 712/P	165	200	235	8	8	66	102	126	4	8	197	-	-	49	276	30	289	324	-	-	-	-	-	-	12
VA 801/P																									
VA 802/P	237	-	-	59	336	40	337	372	-	-	-	-	-	12											
VA 901/P	185	219	250	8	8	83	118	143	4	8	237	-	-	59	336	45	337	372	-	-	-	-	-	-	12
VA 902/P	337	-	-	49	436	50	395	440	-	-	-	-	-	14											

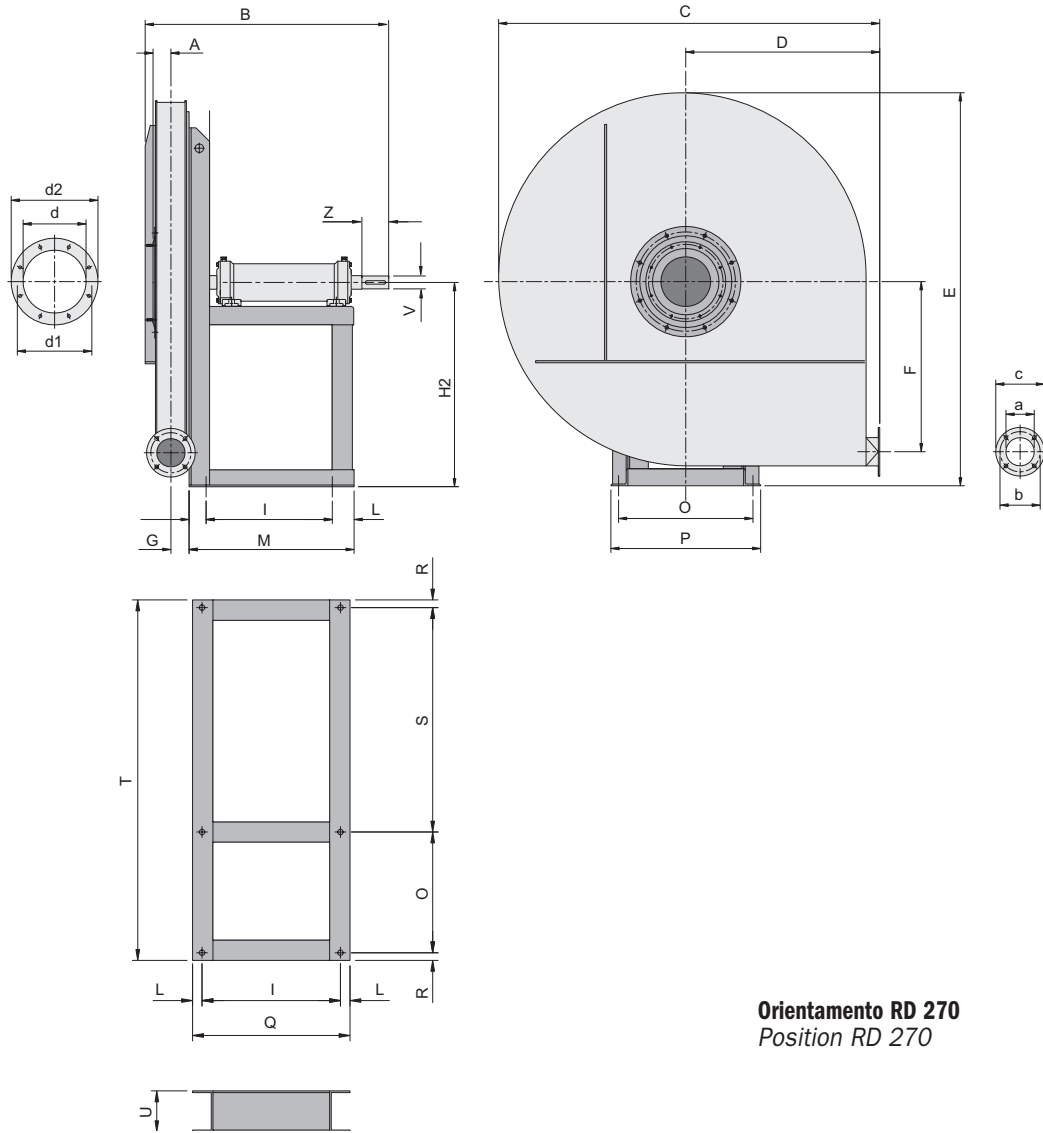

Orientamento RD 270
Position RD 270

Direzioni di rotazione (vista lato motore) - Rotation senses (seen from motor side)

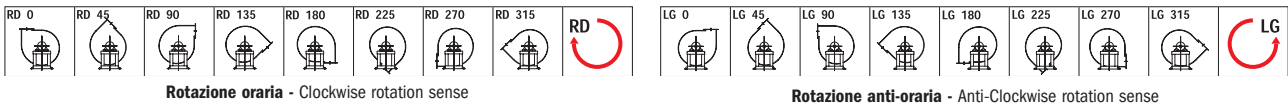

DIMENSIONI D'INGOMBRO

OVERALL DIMENSIONS



VA/T 310÷900

Peso ventilatore in Kgf (completo di motore) - Weight of ventilator (complete with motor)

Nota: Quota B indicativa - Note: B quote indicative

TIPO - TYPE VENTILATORE FAN	PESO WEIGHT	PD ² GD ²			VENTILATORE FAN									
	kgf	kgf m ²	V	Z	A	B	C	D	E	F	G	H	H ₁	H ₂
VA 350 P/T	24	0,23	19	40	34	400	515	270	520	220	30	280	280	280
VA 400 P/T	34	0,37	19	40	34	405	675	350	673	300	31	355	355	355
VA 450 P/T	36	0,53	19	40	34	405	675	350	673	300	31	355	355	355
VA 500 P/T	38	0,73	19	40	34	405	675	350	673	300	31	355	355	355
VA 560 P/T	60	1,1	24	50	34	485	780	405	800	355	32	425	425	425
VA 630 P/T	62	2	24	50	34	485	780	405	800	355	32	425	425	425
VA 710 P/T	93	3,4	28	60	40	650	880	455	900	400	38	475	475	475
VA 800 P/T	106	5,4	28	60	40	650	980	505	1010	450	38	530	530	530
VA 900 P/T	130	10,8	38	80	49	695	1120	570	1140	500	48	600	600	600

TIPO - TYPE VENTILATORE FAN	FLANGIA ASPIRANTE INLET FLANGE					FLANGIA PREMENTE OUTLET FLANGE					BASAMENTO BASE													
	d	d ₁	d ₂	n°	∅	a	b	c	n°	∅	I	J	K	L	M	N	O	P	Q	R	S	T	U	∅
VA 350 P/T	145	182	215	8	8	54	84	104	4	8	210	-	-	17	282	55	228	255	282	13,5	495	750	80	10
VA 400 P/T	145	182	215	8	8	54	84	104	4	8	210	-	-	17	282	55	228	255	282	13,5	495	750	80	10
VA 450 P/T	145	182	215	8	8	54	84	104	4	8	210	-	-	17	282	55	228	255	282	13,5	495	750	80	10
VA 500 P/T	145	182	215	8	8	54	84	104	4	8	210	-	-	17	282	55	228	255	282	13,5	495	750	80	10
VA 560 P/T	145	182	215	8	8	54	84	104	4	8	284	-	-	23	347	40	288	324	347	18	576	900	100	12
VA 630 P/T	145	182	215	8	8	54	84	104	4	8	284	-	-	23	347	40	288	324	347	18	576	900	100	12
VA 710 P/T	165	200	235	8	8	66	102	126	4	8	407	-	-	28	485	50	355	400	485	22,5	660	1060	120	14
VA 800 P/T	165	200	235	8	8	66	102	126	4	8	407	-	-	28	485	50	355	400	485	22,5	660	1060	120	14
VA 900 P/T	185	219	250	8	8	83	118	143	4	8	407	-	-	28	485	50	355	400	485	22,5	660	1060	120	14

CARATTERISTICHE IN MANDATA VENTILATORI SERIE "VA" OUTLET CHARACTERISTICS OF "VA" SERIES VENTILATORS

MOTORE A 2 POLI - 2 POLES MOTORS

TIPO - TYPE																Qv m ³ /h									
VENTILATORE FAN	MOTORE MOTOR	KW inst.	KW ass.	n	dB(A)	72	108	144	180	216	252	288	324	360	396	468	540	612	684	756	828	936	1080		
VA 310/P	63 B2	0,25	0,22	2765	65	185	190	195	200	205															
VA 350/P	71 A2	0,37	0,33	2765	67	235	240	245	250	255	245														
VA 400/P	71 B2	0,55	0,49	2800	69	300	305	310	315	320	325	330													
VA 450/P	80 A2	0,75	0,68	2850	71	375	380	385	395	405	415	425	415												
VA 500/P	80 B2	1,1	1	2850	73	475	480	485	490	495	500	505	510	515											
VA 560/P	90 S2	1,5	1,35	2860	75	595	600	605	610	620	630	640	650	660	645										
VA 631/P	90 S2	1,5	1,4	2860	76	675	680	690	700	710	715	720	725												
VA 632/P	90 L2	2,2	2	2860	77	745	750	760	770	780	790	800	810	815	820	825									
VA 711/P	100 LA2	3	2,6	2885	79	825	830	840	855	870	880	890	900	905	910	915									
VA 712/P	112 M2	4	3,8	2895	80	945	955	965	975	985	995	1005	1015	1025	1035	1045	1060	1075							
VA 801/P	112 M2	4	3,9	2895	82	1035	1045	1055	1065	1075	1085	1095	1105	1115	1130	1145	1160								
VA 802/P	132 SA2	5,5	5,4	2910	84	1145	1155	1165	1180	1195	1205	1215	1225	1235	1250	1265	1280	1295							
VA 901/P	132 MB2	9,2	8,4	2900	86	1275	1285	1295	1311	1325	1335	1345	1355	1365	1380	1395	1410	1425	1445	1465	1475	1485			
VA 902/P	160 MA2	11	10,9	2930	88	1445	1455	1465	1480	1495	1505	1515	1525	1535	1550	1565	1580	1595	1615	1625	1635	1645	1655		

TOLLERANZA SULLA PORTATA $\pm 5\%$ - LOAD TOLERANCE $\pm 5\%$

TOLLERANZA SULLA RUMOROSITÀ $+3\text{dB (A)}$ - NOISE TOLERANCE $+3\text{dB (A)}$

pt mmH2O= da Pa

Valori riferiti a:/ Datas referring to: T=15°C; P=1 atm

VA

PRESTAZIONI VENTILATORI A TRASMISSIONE
BELT DRIVEN FANS PERFORMANCES

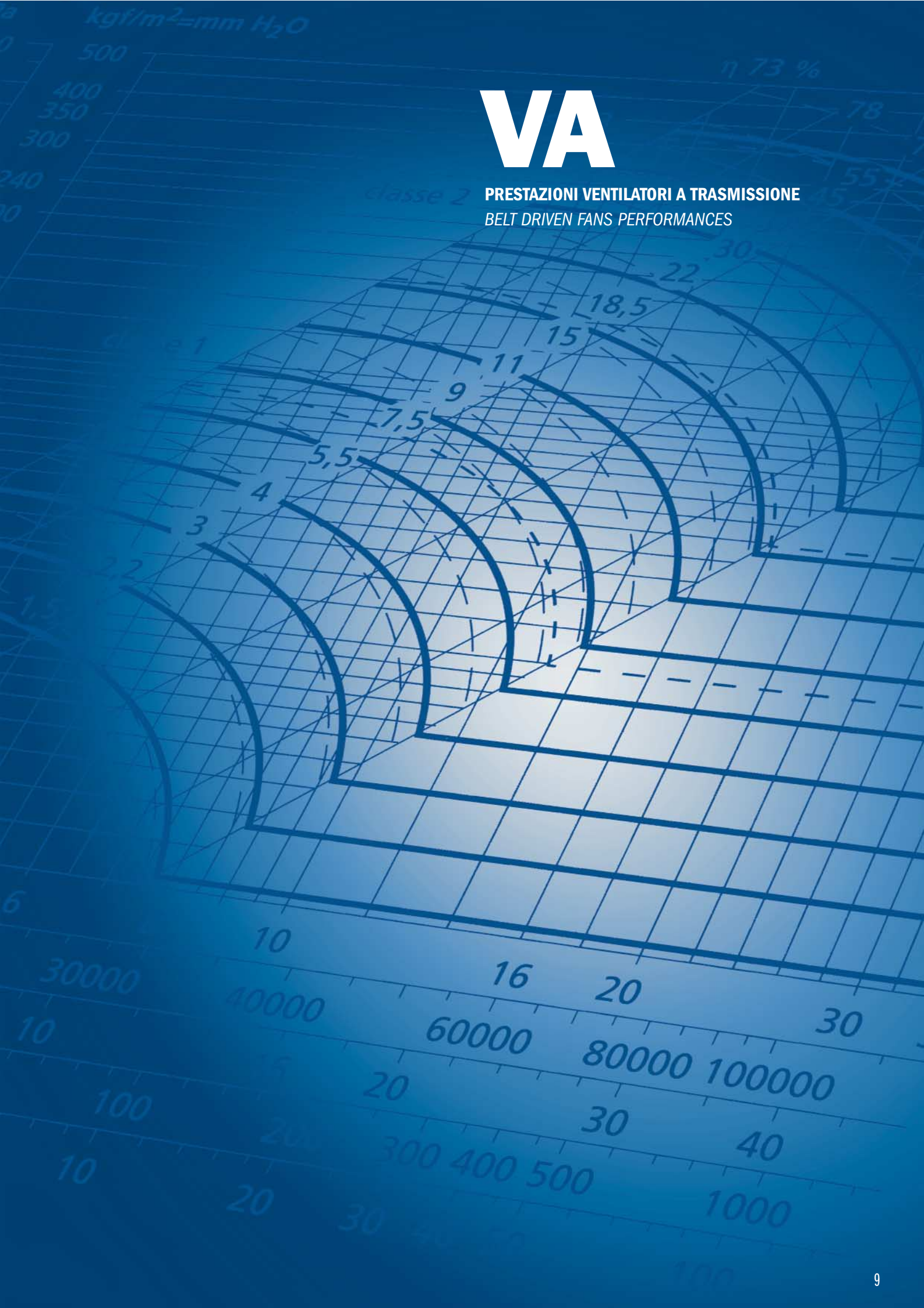



PRESTAZIONI VENTILATORI A TRASMISSIONE

BELT DRIVEN FANS PERFORMANCES

VA 350P/T

Il ventilatore è orientabile
The fan is revolvable

Peso ventilatore in kgf 24
Weight of ventilator in kgf 24

PD² = 0,23 kgf m²
GD² = 0,23 kgf m²

Massima velocità di rotazione
Maximum rotation speed

<100°C = 5000
100÷200°C = 4500
200÷300°C = 4000

Tolleranza sulla rumorosità + 3 dB(A)
Noise tolerance + 3 dB(A)

Tolleranza sulla potenza assorbita ± 3%
Absorbed power tolerance ± 3%

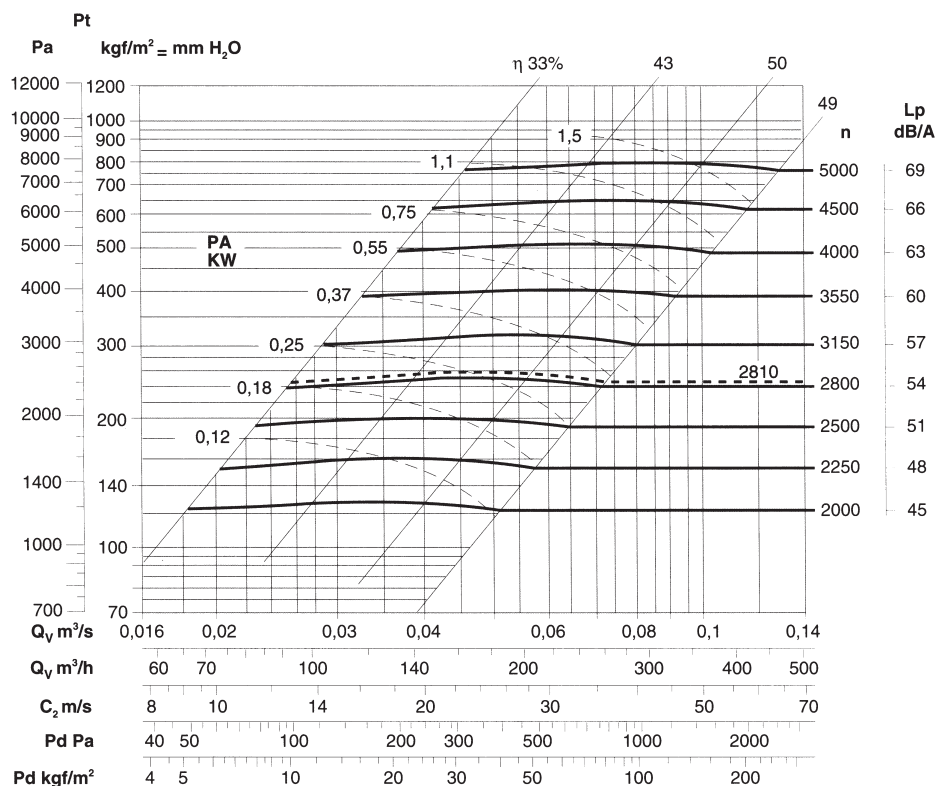

VA 400P/T

Il ventilatore è orientabile
The fan is revolvable

Peso ventilatore in kgf 34
Weight of ventilator in kgf 34

PD² = 0,37 kgf m²
GD² = 0,37 kgf m²

Massima velocità di rotazione
Maximum rotation speed

<100°C = 4750
100÷200°C = 4250
200÷300°C = 3750

Tolleranza sulla rumorosità + 3 dB(A)
Noise tolerance + 3 dB(A)

Tolleranza sulla potenza assorbita ± 3%
Absorbed power tolerance ± 3%

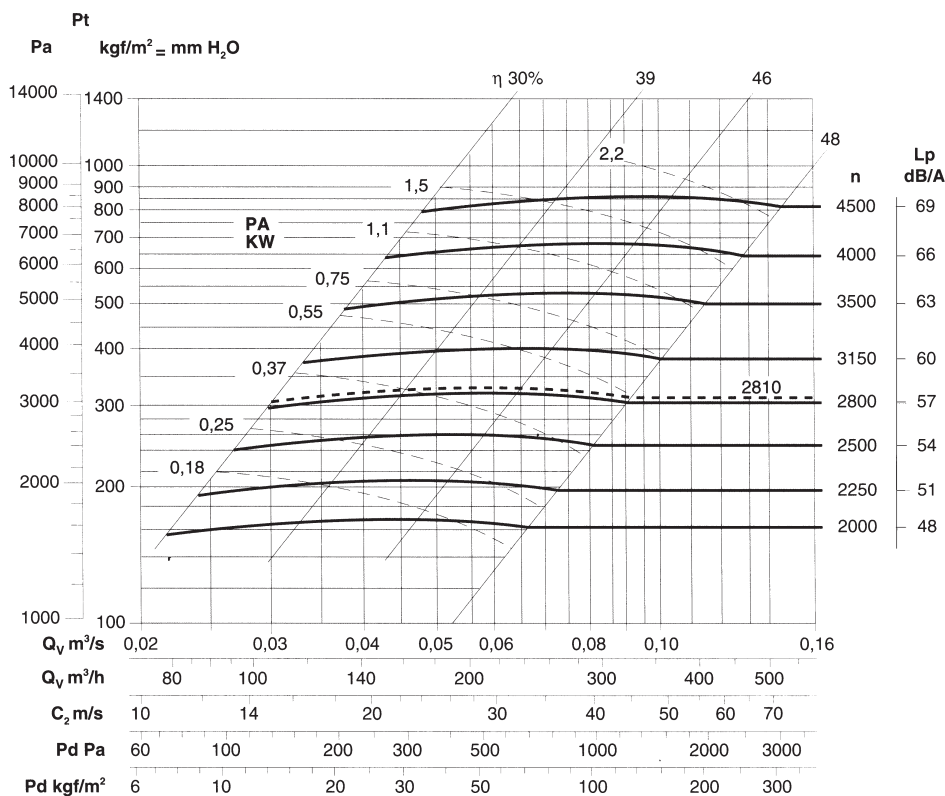

PRESTAZIONI VENTILATORI A TRASMISSIONE

BELT DRIVEN FANS PERFORMANCES



VA 450P/T

Il ventilatore è orientabile
The fan is revolvable

Peso ventilatore in kgf 36
Weight of ventilator in kgf 36

PD² = 0,53 kgf m²

Massima velocità di rotazione
Maximum rotation speed

<100°C = 4500
100÷200°C = 4000
200÷300°C = 3750

Tolleranza sulla rumorosità + 3 dB(A)
Noise tolerance + 3 dB(A)

Tolleranza sulla potenza assorbita ± 3%
Absorbed power tolerance ± 3%

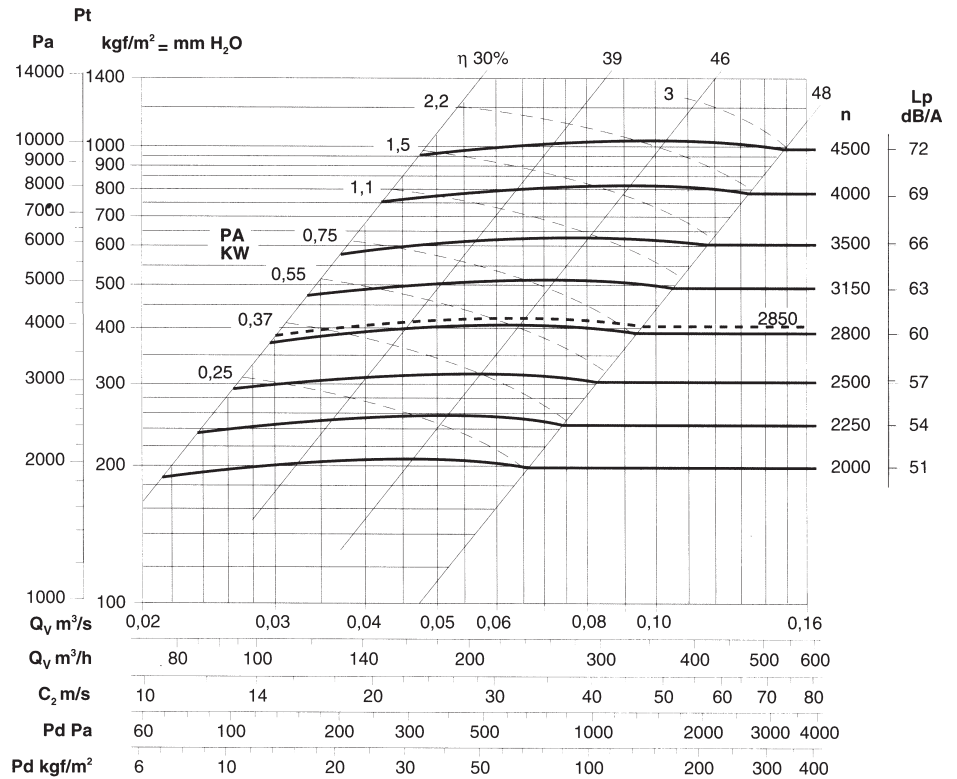

VA 500P/T

Il ventilatore è orientabile
The fan is revolvable

Peso ventilatore in kgf 38
Weight of ventilator in kgf 38

PD² = 0,73 kgf m²

Massima velocità di rotazione
Maximum rotation speed

<100°C = 4250
100÷200°C = 3750
200÷300°C = 3350

Tolleranza sulla rumorosità + 3 dB(A)
Noise tolerance + 3 dB(A)

Tolleranza sulla potenza assorbita ± 3%
Absorbed power tolerance ± 3%

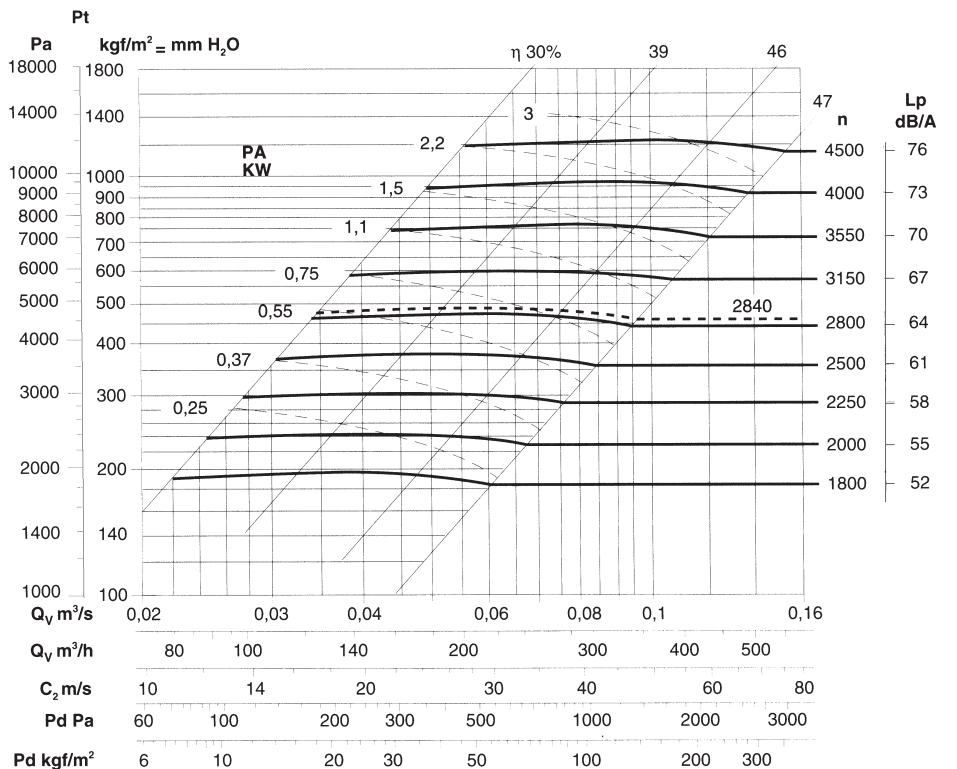



PRESTAZIONI VENTILATORI A TRASMISSIONE

BELT DRIVEN FANS PERFORMANCES

VA 560P/T

Il ventilatore è orientabile
The fan is revolvable

Peso ventilatore in kgf 60
Weight of ventilator in kgf 60

PD² = 1,1 kgf m²
GD² = 1,1 kgf m²

Massima velocità di rotazione
Maximum rotation speed

<100°C = 4000
100÷200°C = 3500
200÷300°C = 3250

Tolleranza sulla rumorosità + 3 dB(A)
Noise tolerance + 3 dB(A)

Tolleranza sulla potenza assorbita ± 3%
Absorbed power tolerance ± 3%

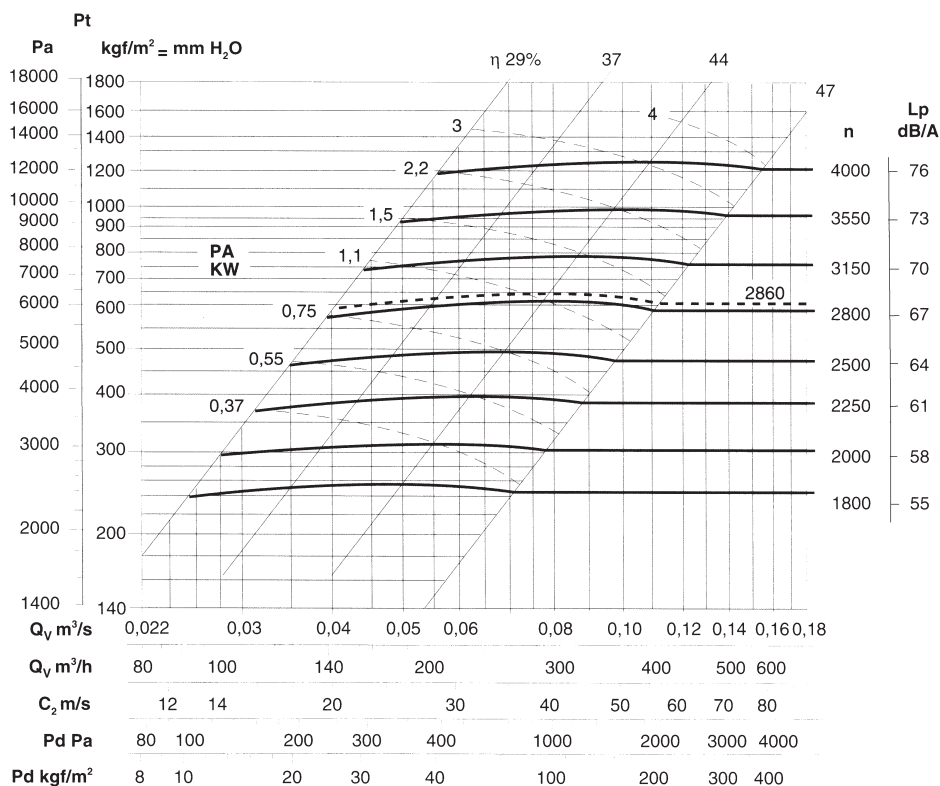

VA 630P/T

Il ventilatore è orientabile
The fan is revolvable

Peso ventilatore in kgf 62
Weight of ventilator in kgf 62

PD² = 2 kgf m²
GD² = 2 kgf m²

Massima velocità di rotazione
Maximum rotation speed

<100°C = 3750
100÷200°C = 3350
200÷300°C = 3000

Tolleranza sulla rumorosità + 3 dB(A)
Noise tolerance + 3 dB(A)

Tolleranza sulla potenza assorbita ± 3%
Absorbed power tolerance ± 3%

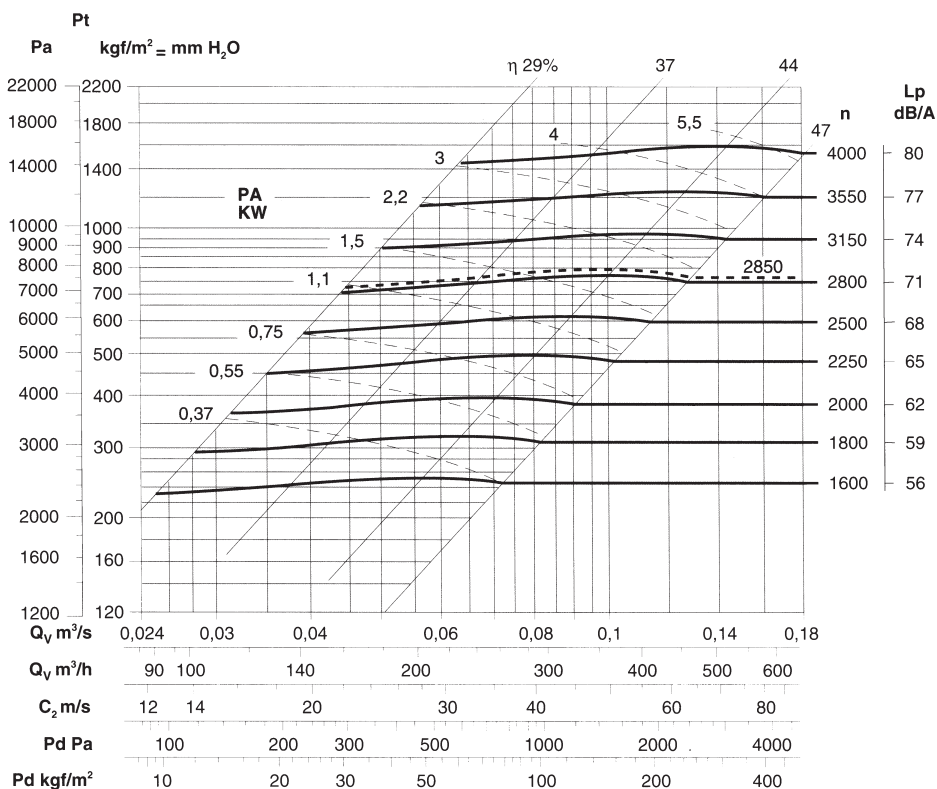

PRESTAZIONI VENTILATORI A TRASMISSIONE BELT DRIVEN FANS PERFORMANCES



VA 710P/T

Il ventilatore è orientabile
The fan is revolvable

Peso ventilatore in kgf 93
Weight of ventilator in kgf 93

PD² = 3,4 kgf m²
GD² = 3,4 kgf m²

Massima velocità di rotazione
Maximum rotation speed

<100°C = 3550
100÷200°C = 3150
200÷300°C = 2800

Tolleranza sulla rumorosità + 3 dB(A)
Noise tolerance + 3 dB(A)

Tolleranza sulla potenza assorbita ± 3%
Absorbed power tolerance ± 3%

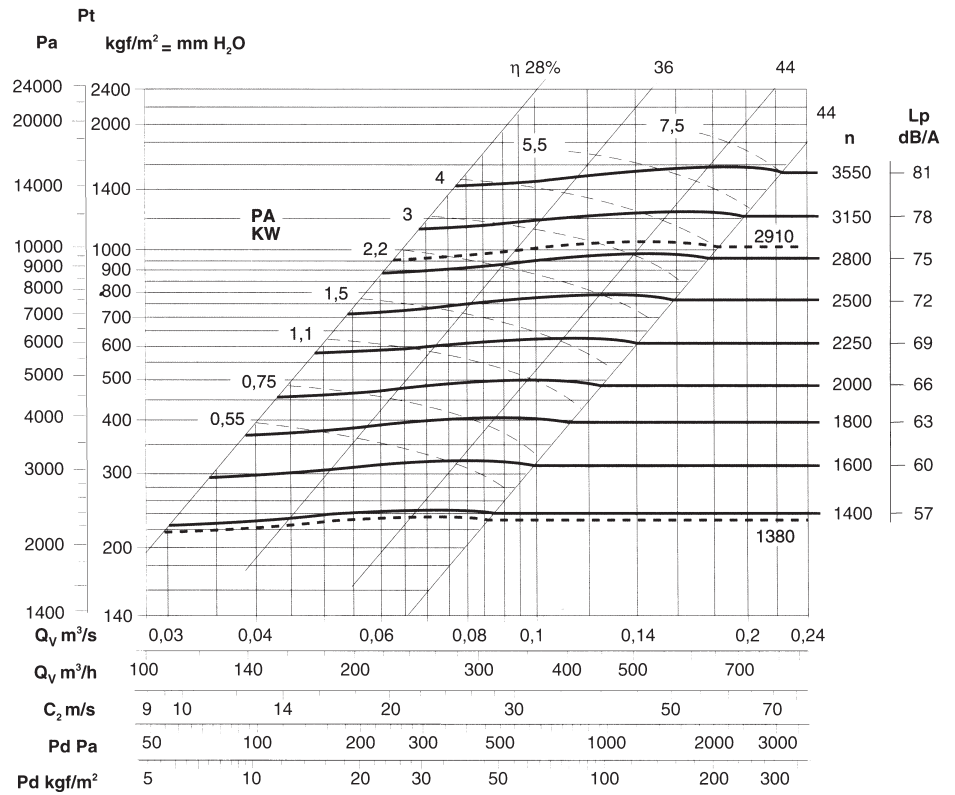

VA 800P/T

Il ventilatore è orientabile
The fan is revolvable

Peso ventilatore in kgf 106
Weight of ventilator in kgf 106

PD² = 5,4 kgf m²
GD² = 5,4 kgf m²

Massima velocità di rotazione
Maximum rotation speed

<100°C = 3350
100÷200°C = 3000
200÷300°C = 2650

Tolleranza sulla rumorosità + 3 dB(A)
Noise tolerance + 3 dB(A)

Tolleranza sulla potenza assorbita ± 3%
Absorbed power tolerance ± 3%

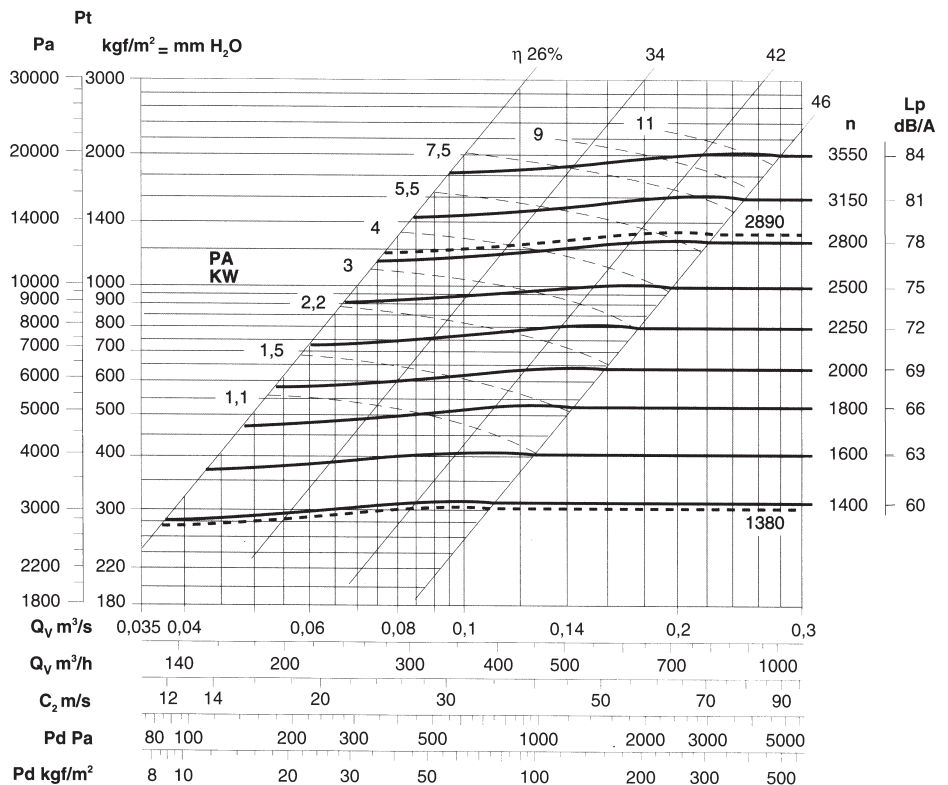



PRESTAZIONI VENTILATORI A TRASMISSIONE

BELT DRIVEN FANS PERFORMANCES

VA 900P/T

Il ventilatore è orientabile
The fan is revolvable

Peso ventilatore in kgf 130
Weight of ventilator in kgf 130

PD² = 10,8 kgf m²
GD² = 10,8 kgf m²

Massima velocità di rotazione
Maximum rotation speed

<100°C = 3150
 100÷200°C = 2800
 200÷300°C = 2500

Tolleranza sulla rumorosità + 3 dB(A)
Noise tolerance + 3 dB(A)

Tolleranza sulla potenza assorbita ± 3%
Absorbed power tolerance ± 3%

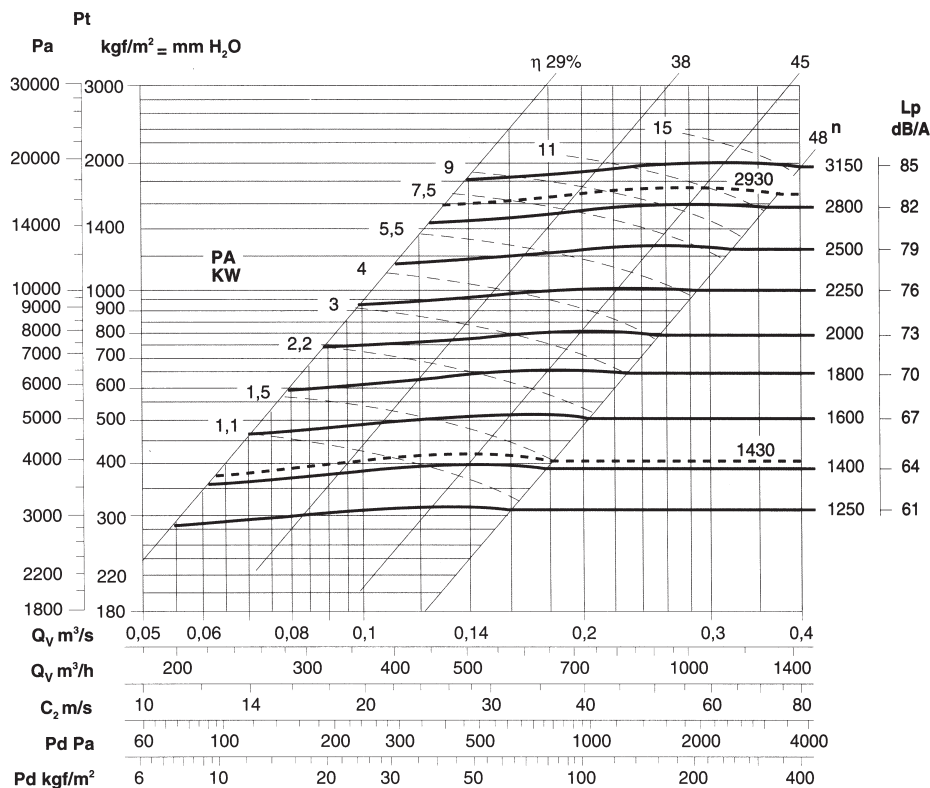

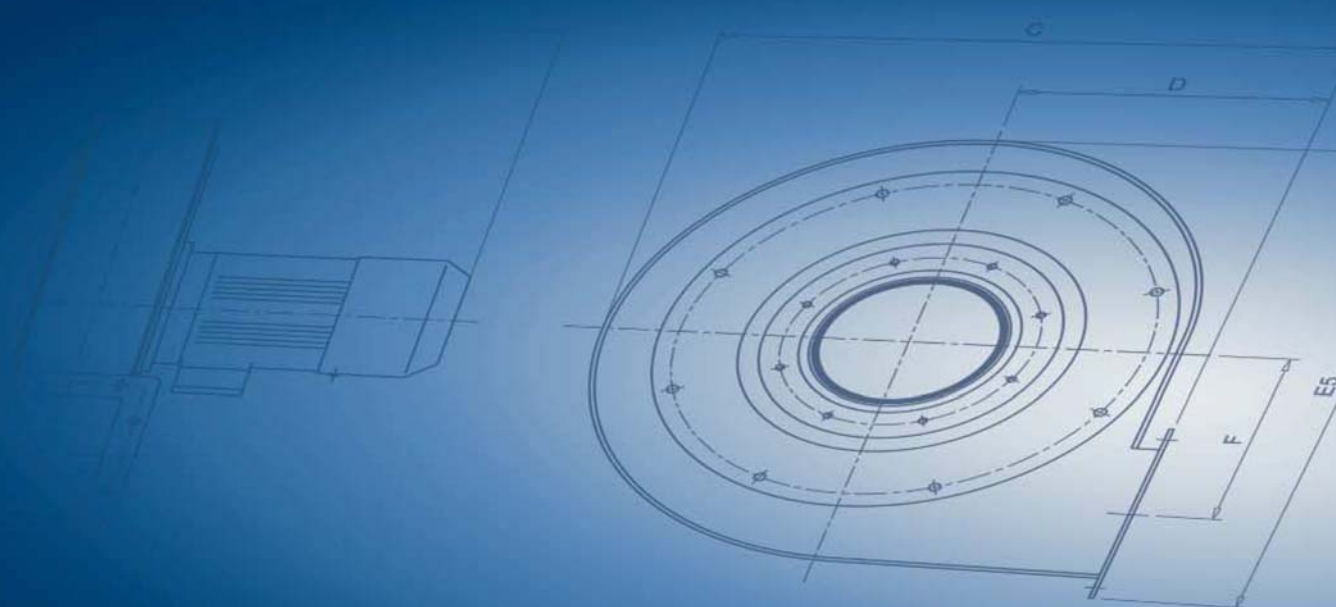

ACF Ventilatoren GmbH | Elf Stücken 21 | 49324 Melle | Tel.: +49(0)5422-9895-0 | Fax +49(0)5422-9895-15
www.acf-ventilatoren.de | info@acf-ventilatoren.de